

asr-power.schdoc

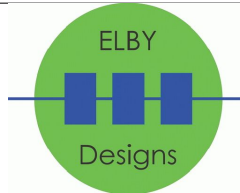

5 Dunning Avenue  
George Town  
TAS 7253  
Australia

**IMPORTANT NOTICE:**  
Information disclosed by this drawing is the property of ELBY Designs.  
Duplication or manufacturing rights granted by written permission only.



## CGS334 - Analog Shift-Register Clock and CV Input Buffers

Size A4	FCSM No. 7/04/2023	DWG No. asr-input.schdoc	Rev V2.1
Scale	Laurie Biddulph		Sheet 1 of 3

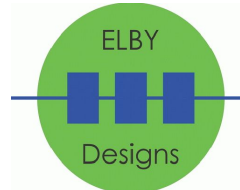
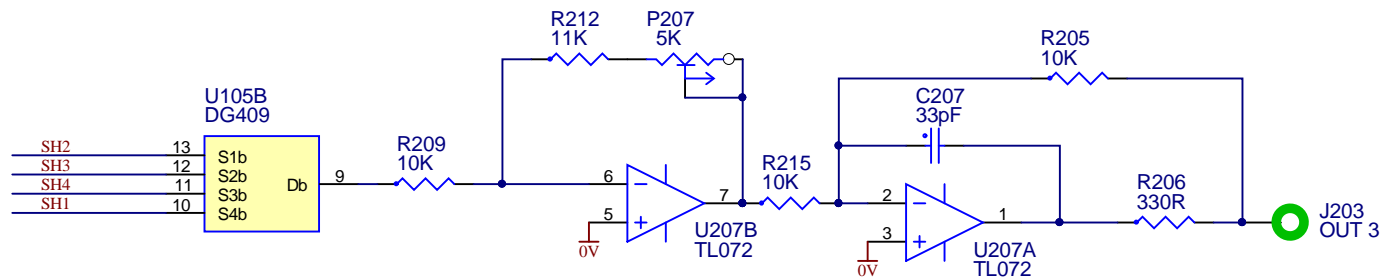
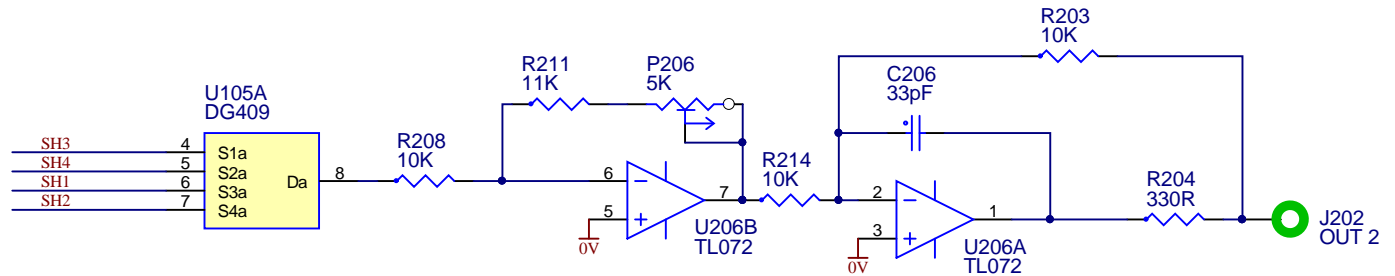
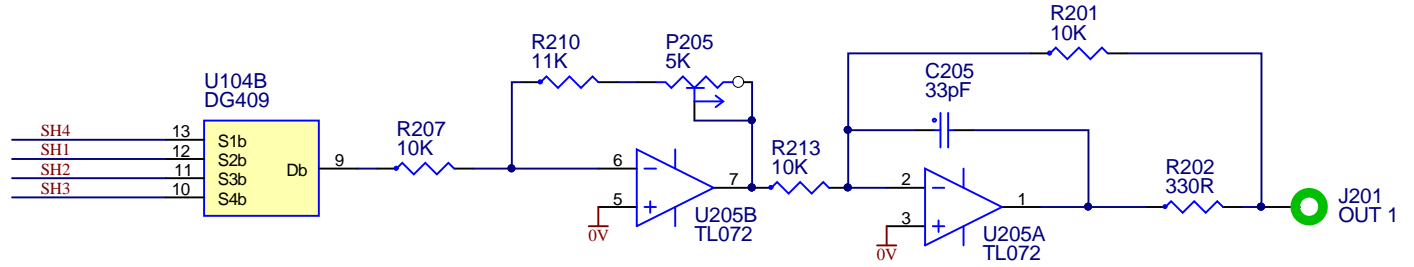
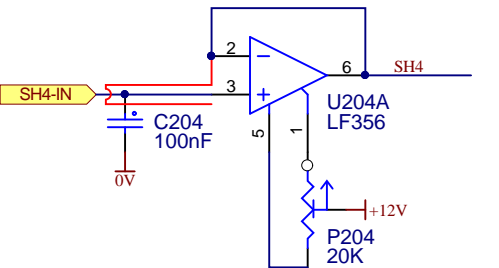
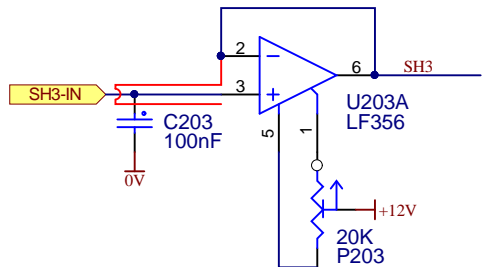
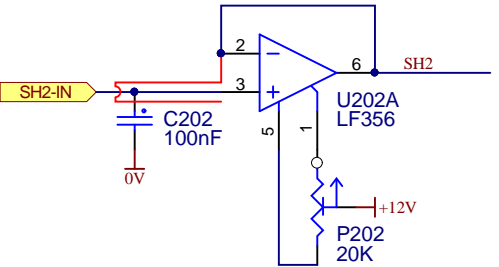
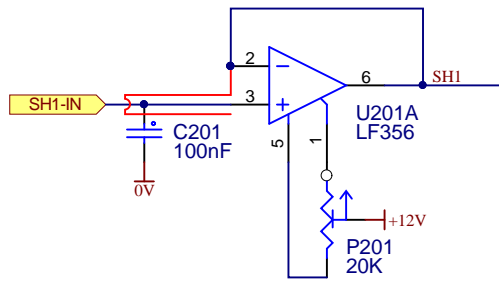

5 Dunning Avenue  
George Town  
TAS 7253  
Australia

**IMPORTANT NOTICE:**  
Information disclosed by this drawing is the property of ELBY Designs.  
Duplication or manufacturing rights granted by written permission only.



## CGS334 - Analog Shift-Register Sample & Hold

Size A4	FCSM No. 7/04/2023	DWG No. asr-sh.schdoc	Rev V2.1
Scale	Laurie Biddulph		Sheet 2 of 3

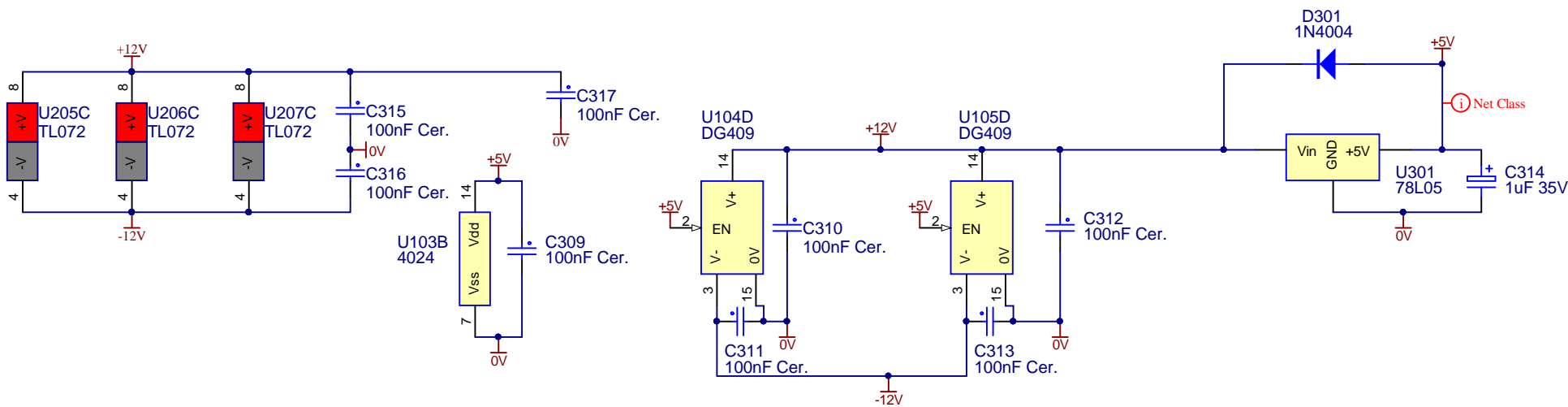
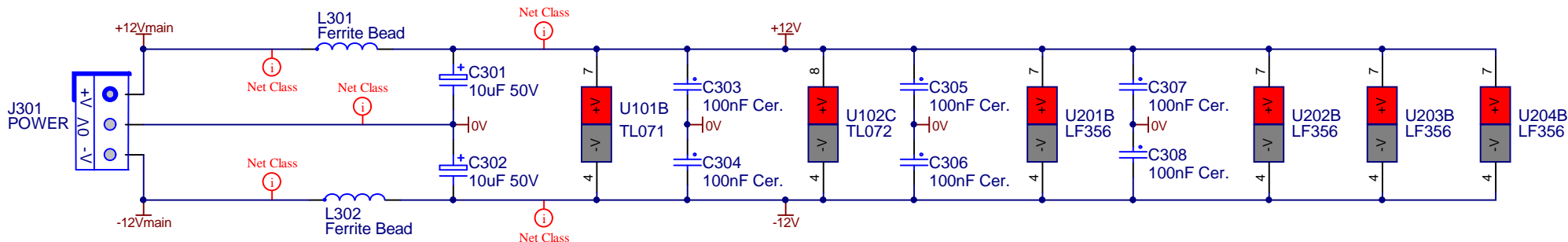

LOGO-ELBY

LOGO-CGS

RCM

RoHS

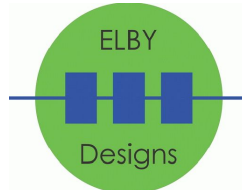

5 Dunning Avenue  
George Town  
TAS 7253  
Australia

**IMPORTANT NOTICE:**

Information disclosed by this drawing is the property of ELBY Designs. Duplication or manufacturing rights granted by written permission only.



**CGS334 - Analog Shift-Register  
Power Supply**

Size A4	FCSM No. 7/04/2023	DWG No. asr-power.schdoc	Rev V2.1
Scale	Laurie Biddulph		Sheet 3 of 3